

2654

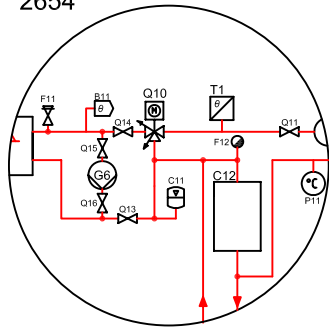

2554

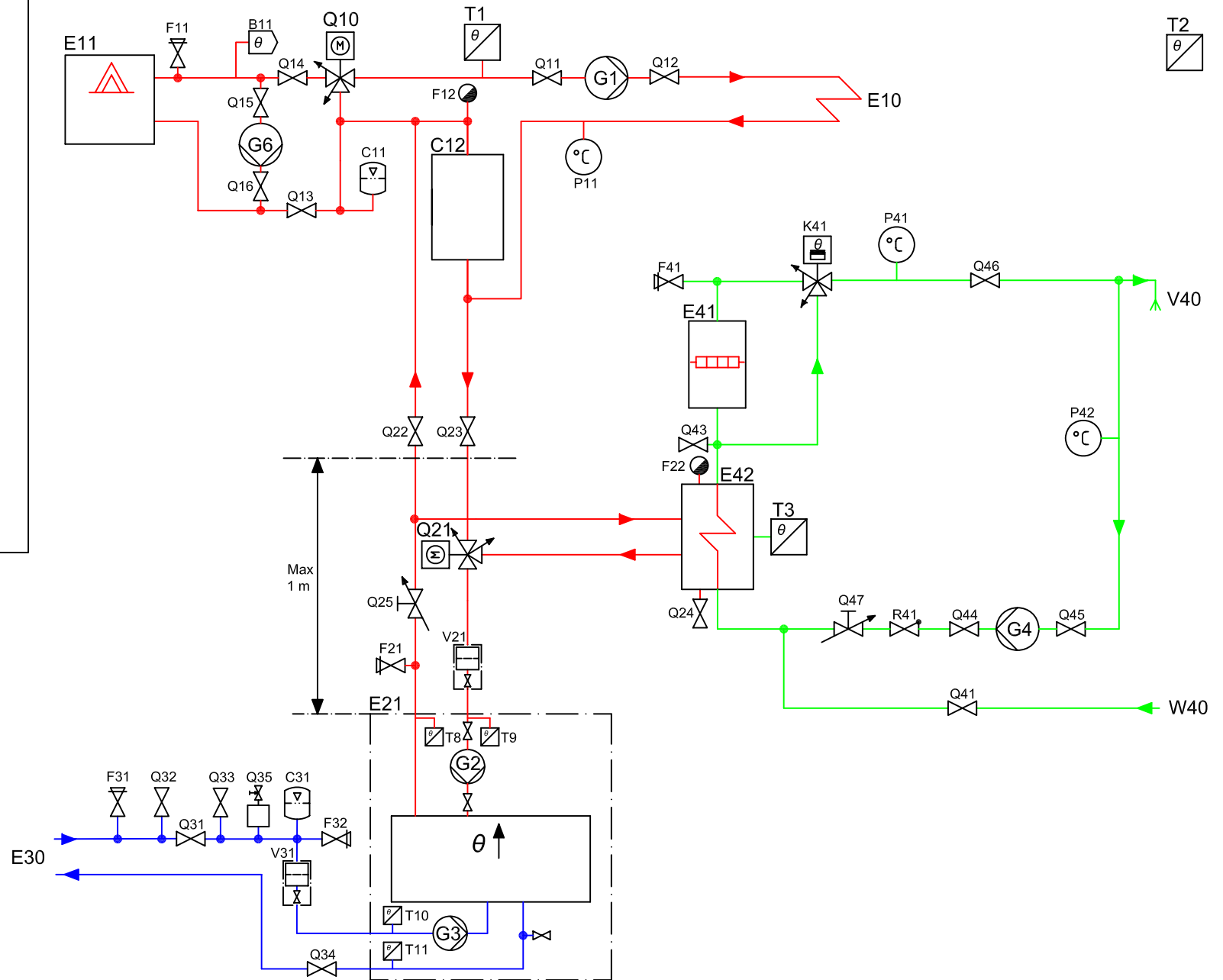
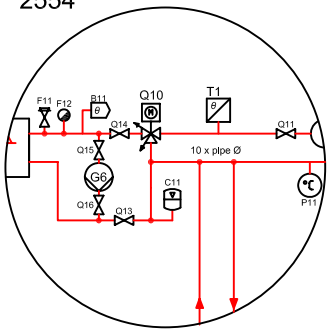

Symbols according to SS-ISO 14617
 Letter codes according to IEC 61346-2
 This is a principal drawing



Systemlösning för
 Greenline
 G och G+

Edition	2	Date	080327
Drawing number	2654/2554	Drawn by	PD/EH