

2630

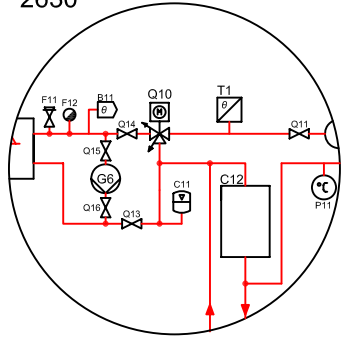

2530

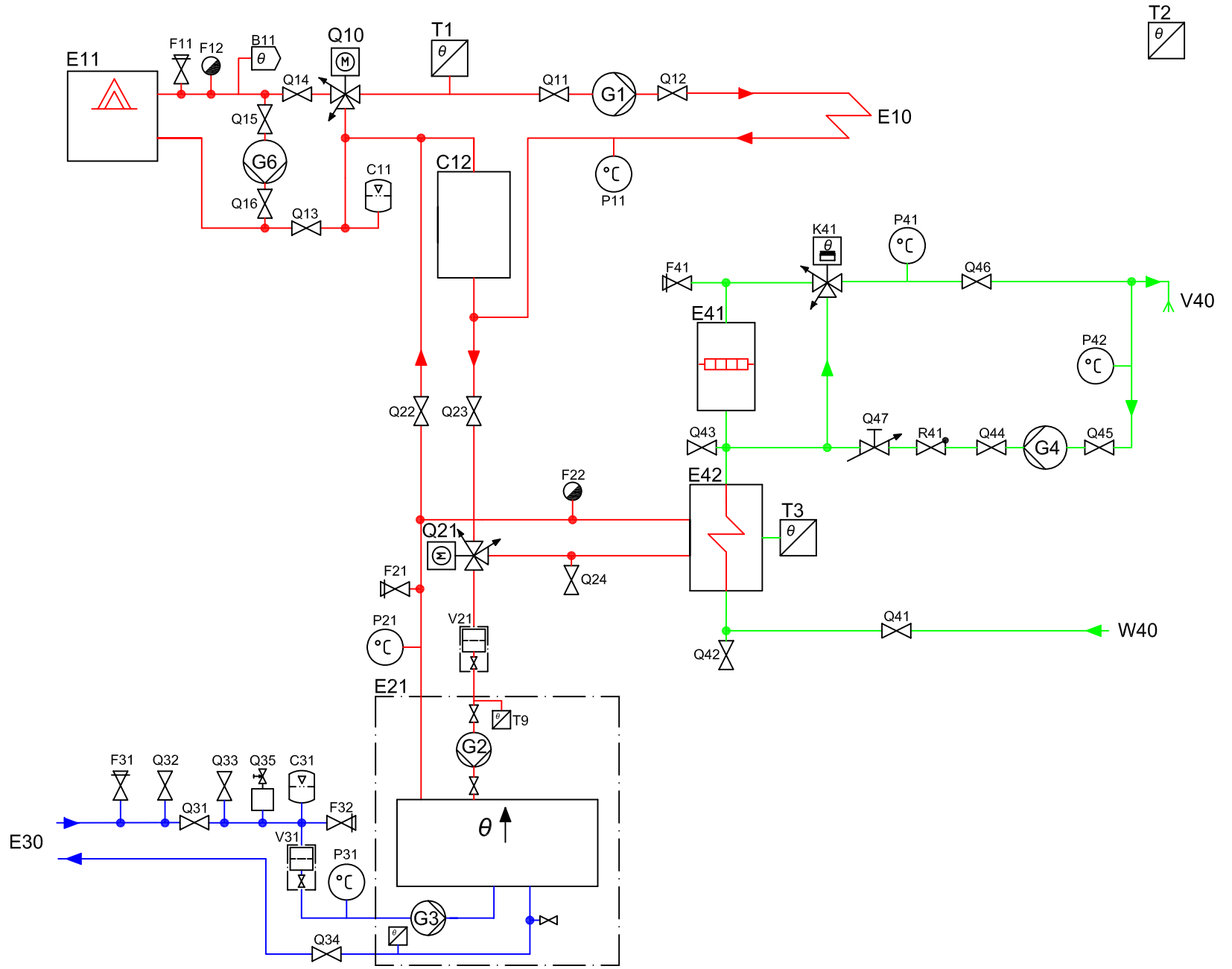
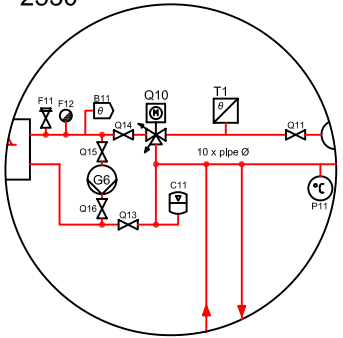

Symbols according to SS-ISO 14617  
 Letter codes according to IEC 61346-2  
 This is a principal drawing



Edition	1	Date	061211
Drawing number	2630/2530	Drawn by	PQ